



*Acryzen 7242 R OR
RI with Optional Skirt*





ACRYZEN 7242 R

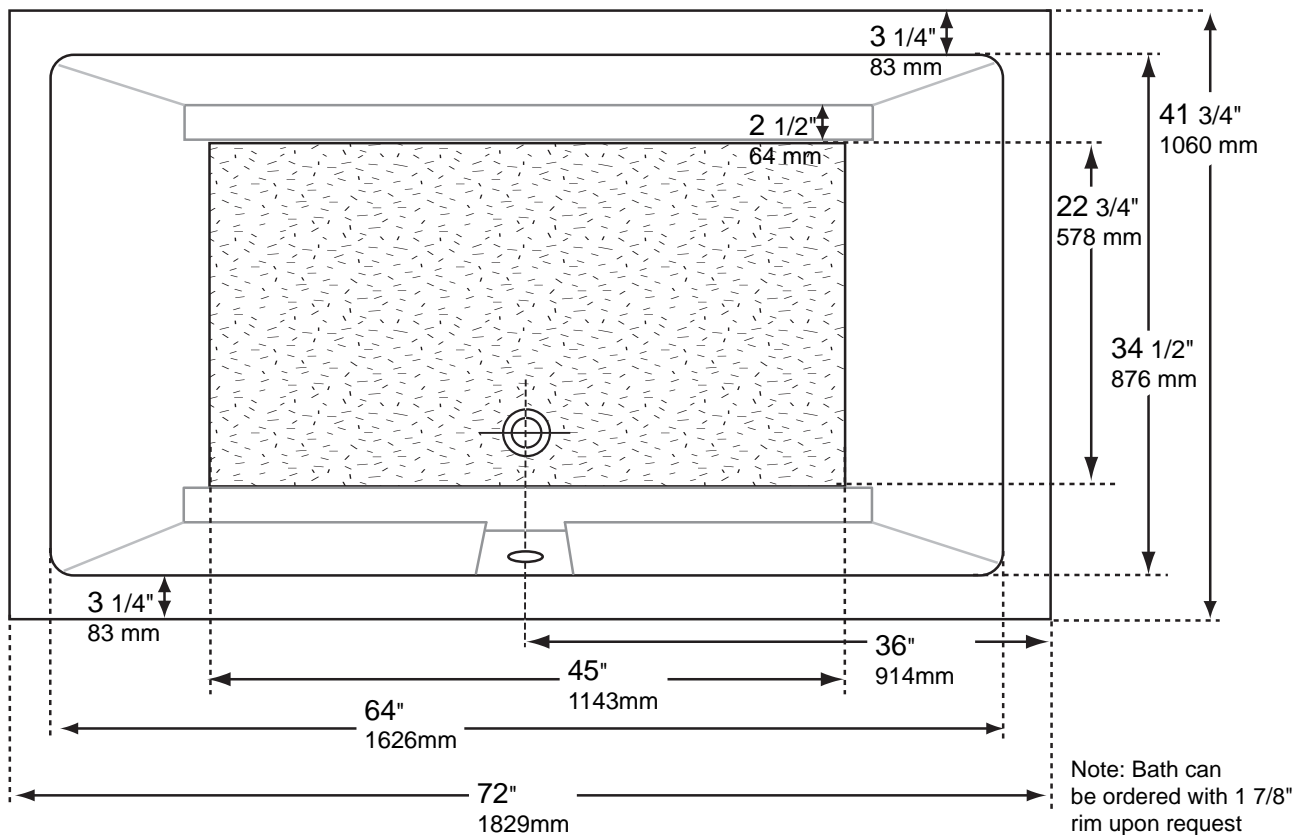

Note: Bath can be ordered with 1 7/8" rim upon request

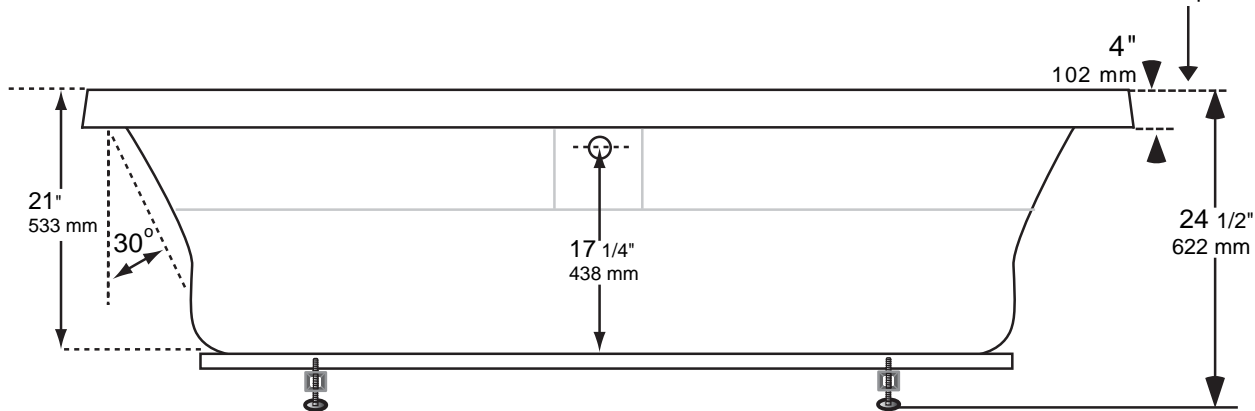

Overall outer dimensions may vary plus or minus 1/4 inch.
 Inner dimensions of flat surfaces show minimum flat surface dimension for construction purposes only.
 Radius or curve length is not shown.
 The sum of the flat surface dimensions will not equal overall length.

All published dimensions are for reference only. Any critical dimensions required for installation should be taken directly from the bath being installed.

Total height is taken from a level floor with leg completely extended to maximum height double tapped.

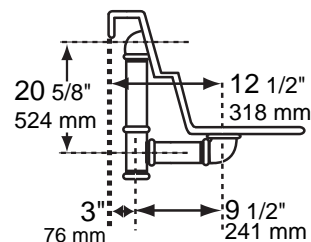

November 2006



Acryzen 7242R or RI

Available as Drop-in or Island Bath

Technical Specification

Available Configurations

Model Statistics

▶ Soaking Bath	Number of gallons 3 inches from overflow:	80 US gallons
▶ Aquamasseur System Bath - 18 injectors	Number of headrests:	0
	Lumbar support:	2
	Armrests:	yes
▶ Healthmasseur System Bath - 59 Air Portals ○ (includes 1 heated backrest)	Water depth to bottom of overflow:	16"
▶ Ultimate System Bath ○ (includes 1 heated backrest)	Number of bathers:	maximum of 2

Meets the requirements of:

- ANSI Z - 124.1/CSA-B 45/B 45.5
- ANSI A - 112.19.7/ A-112.19.8
- UL - 1795/CSA C 22.2 NO. 218.2-93

CHOICES COMMON TO ALL CONFIGURATIONS:

- | | |
|--|--|
| ▶ Standard Colors: White, Biscuit or Bone. | ▶ Optional 1 pc Acrylic Skirt with Access Panels |
| ▶ Optional Colors: Consult factory for availability. | ▶ Acrylic Decorative Grab bar (optional 12"). |
| ▶ Chromatherapy Light (optional). | ▶ Turnstyle Waste & Overflow (factory installed). |
| | ▶ Self supporting powder coated steel frame with adjustable cadmium legs (no mortar). |

SYSTEM BATH CHOICES

Healthmasseur

The healthmasseur system delivers a massage ranging from an intermediate to highly vigorous tissue massage. A free-flowing and pressure balanced channel is hand laminated to the perimeter edge of the bath well. This channel provides a uniform flow of warmed air throughout the bath and creates convection currents that encircle your body and massage you. Our engineering ensures that no portion of the channel will be defeated by water pressure during operation and that gravity will drain the channel of residual water following operation. The system delivers a vibrant tissue massage over the entire body.

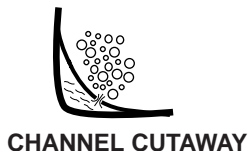

Choices Applicable To Both Systems

← 1 hp blower with heating element and muffler. →

Healthmasseur requires one 15 AMP 120 V circuit protected by GFI
 Aquamasseur requires one 15 AMP 120 V circuit protected by GFI
 Ultimate requires two 15 AMP 120 V circuits protected by GFI

- Multifunction electronic control**
 with white touchpad and white trim ring
 or biscuit touchpad and biscuit trim ring.
- on/off blower control -
 - on/off heating element control -
 - 20 minute bath timer -
 - indicator lights -
 - variable speed control -
 - wave or pulse mode control -
 - auto dry cycle -
 - 24hr programmable purge cycle -

Options Applicable To Both

- Blower Relocation Kits
- Optional Trim Ring on White Touchpad
- Brass, Brushed Nickel or Chrome -

Aquamasseur

The aquamasseur system delivers a massage range from tactile / fingertip to intermediate tissue massage. A series of air injectors are placed throughout the bath well having no more than three injectors in a series connected to 8 distinct air hoses that are fed by a pressure balancing manifold. The engineering of the air pressure delivery system allows us to deliver a very low to intermediate volume of air allowing for both a tactile sensory massage as well as a light tissue massage. Our injectors are placed to follow the meridians of the central nervous system so that the massage created stimulates circulatory blood flow.

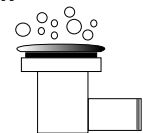

Aquamasseur Injector Choices

Standard Cap

White, Biscuit or Bone

Actual Diameter - 15/16"

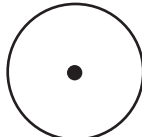

Optional Mini Injectors

18 center cap and trim ring choices

Actual Diameter - 5/8"



ULTIMATE SYSTEM

The ultimate system is a unique combination of our healthmasseur channel technology and our aquamasseur injection technology. In combining the two technologies in one bath, we have provided each of our bathers with an ability to customize their every bath. If their muscles are fatigued they can turn both systems on and get a serious all over tissue massage, but if they are just stressed they can turn on only the aquamasseur system and let thousands of bubbles caress the cares of the day away. If they aren't sure what type of massage they want, they can adjust the two systems until they reach the optimum massage for their day. It is the ability to tailor your massage that results in "The Ultimate Bathing Experience"®.







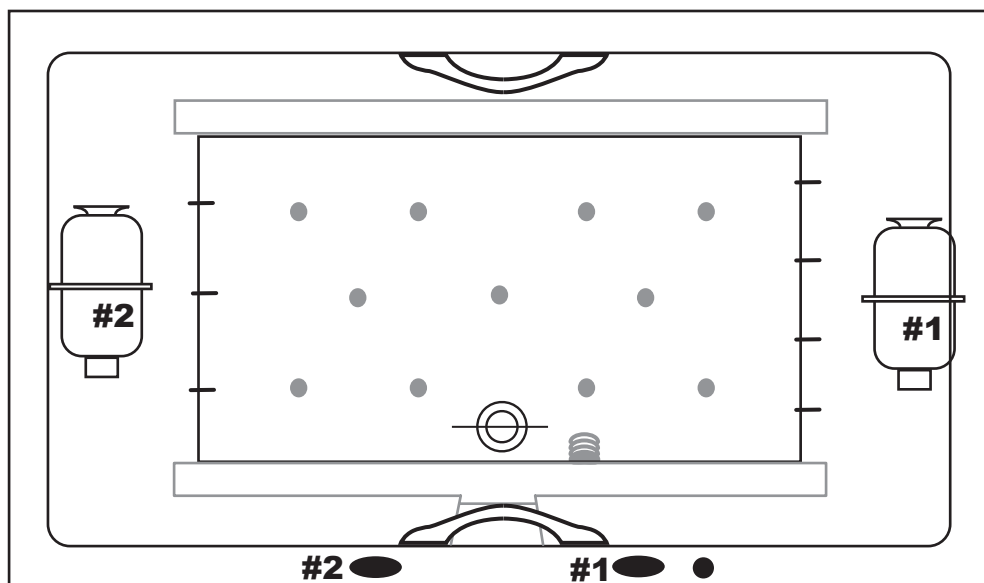



ACRYZEN 7242R or RI

STANDARD POSITIONING

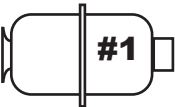

***FOR ALTERNATE CONTROL LOCATION
PLEASE INDICATE REQUIRED LOCATION
AND RETURN WITH ORDER FORM**

- #1**  **Multi-Function control**
- #2**  **2ND Multi-Function control when Ultimate**
-  **Electronic light control**
-  **12" Acrylic grab bars**
-  **#1 Health or Aquamasseur blower when single system**
-  **#2 2ND blower when Ultimate (aquamasseur)**
-  **Chromatherapy light**
-  **Back & bottom aquamasseur injectors**

November 2006