

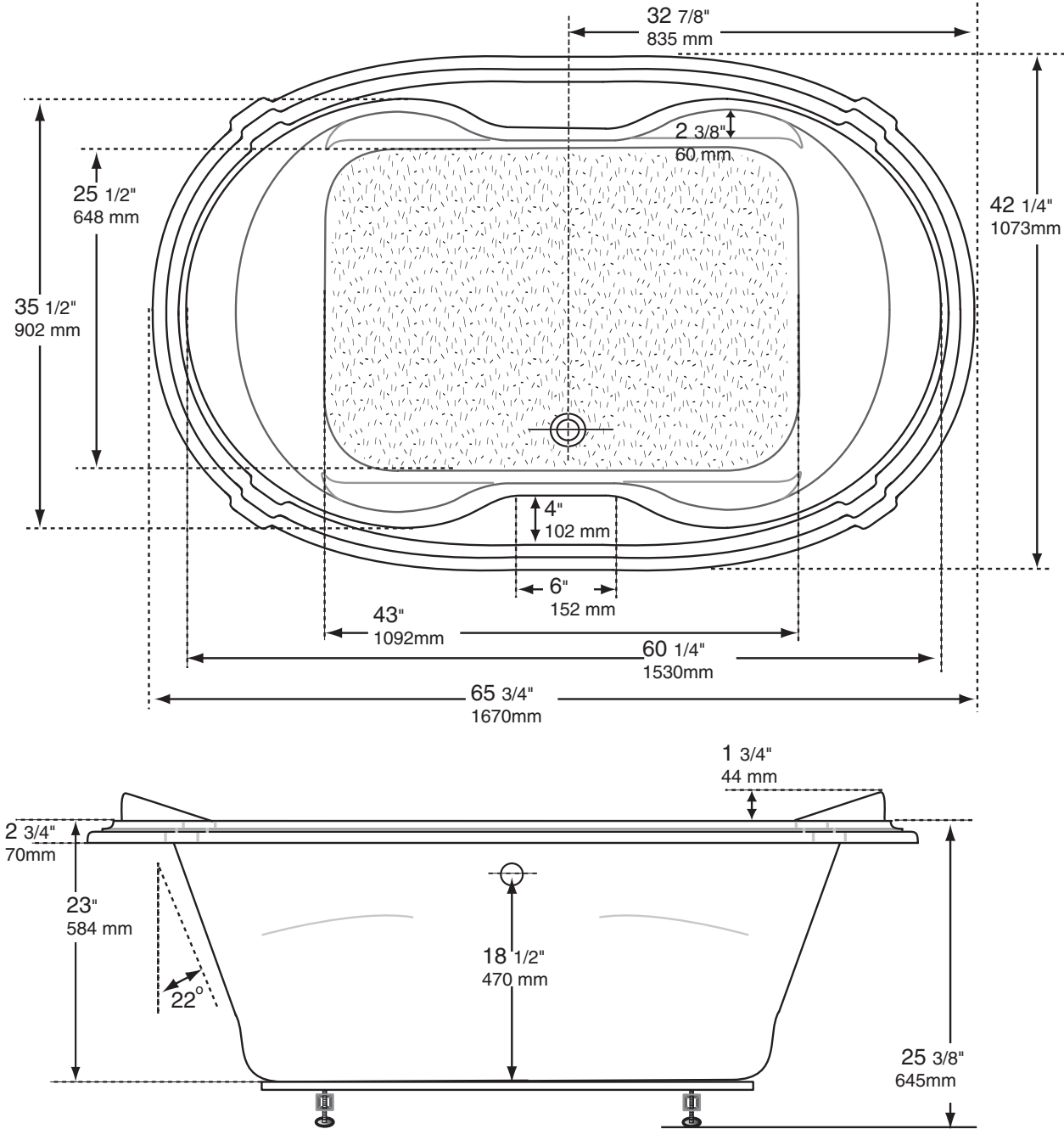

Vision



Vision



Overall outer dimensions may vary plus or minus 1/4 inch.
Inner dimensions of flat surfaces show minimum flat surface dimension for construction purposes only.
Radius or curve length is not shown.
The sum of the flat surface dimensions will not equal overall length.

All published dimensions are for reference only. Any critical dimensions required for installation should be taken directly from the bath being installed.

Total height is taken from a level floor with leg completely extended to maximum height double tapped.

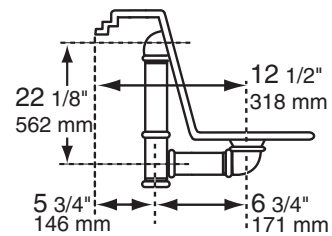

Technical Specification

Available Configurations

- ▶ **Soaking Bath**
- ▶ **Aquamasseur System Bath - 18 injectors**
 - (includes 1 heated headrest)
- ▶ **Healthmasseur System Bath - 55 Air Portals**
 - (includes 1 heated headrest)
- ▶ **Ultimate System Bath**
 - (includes 2 heated headrest)

Model Statistics

Number of gallons 3 inches from overflow:	63 US gallons 52 imperial gallons
Number of headrests:	2
Lumbar support:	2
Armrests:	yes
Water depth to bottom of overflow:	17 1/4"
Number of bathers:	maximum of 1

Meets the requirements of:

ANSI Z124.1 (1995), ANSI Z124.2 (1995) / CSA B45.5-02, CSA B45.0-02
UL1795 Third Edition, Rev. Sept.2006 / CSA C22.2 No.218.2-93 (R2004)
ASME A112.19.7

CHOICES COMMON TO ALL CONFIGURATIONS:

- ▶ Standard Colors: White, Biscuit or Bone.
- ▶ Optional Colors: Consult factory for availability.
- ▶ Chromatherapy Light (optional).
- ▶ Turnstyle Waste & Overflow (optional).
- ▶ Self supporting powder coated steel frame with adjustable cadmium legs (no mortar).

SYSTEM BATH CHOICES

Healthmasseur

The healthmasseur system delivers a massage ranging from an intermediate to highly vigorous tissue massage. A free-flowing and pressure balanced channel is hand laminated to the perimeter edge of the bath well. This channel provides a uniform flow of warmed air throughout the bath and creates convection currents that encircle your body and massage you. Our engineering ensures that no portion of the channel will be defeated by water pressure during operation and that gravity will drain the channel of residual water following operation. The system delivers a vibrant tissue massage over the entire body.

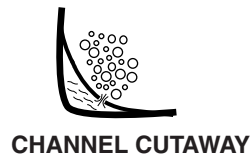

Choices Applicable To Both Systems

1 hp blower with heating element and muffler.

Healthmasseur requires one 15 AMP 120 V circuit protected by GFI
Aquamasseur requires one 15 AMP 120 V circuit protected by GFI
Ultimate requires two 15 AMP 120 V circuits protected by GFI

- Multifunction electronic control**
with white touchpad and white trim ring
or biscuit touchpad and biscuit trim ring.
- on/off blower control -
 - on/off heating element control -
 - 20 minute bath timer -
 - indicator lights -
 - variable speed control -
 - wave or pulse mode control -
 - auto dry cycle -
 - 24hr programmable purge cycle -

Options Applicable To Both

- Blower Relocation Kits
- Optional Trim Ring on White Touchpad
- Brass, Brushed Nickel or Chrome -

Aquamasseur

The aquamasseur system delivers a massage range from tactile / fingertip to intermediate tissue massage. A series of air injectors are placed throughout the bath well having no more than three injectors in a series connected to 10 distinct air hoses that are fed by a pressure balancing manifold. The engineering of the air pressure delivery system allows us to deliver a very low to intermediate volume of air allowing for both a tactile sensory massage as well as a light tissue massage. Our injectors are placed to follow the meridians of the central nervous system so that the massage created stimulates circulatory blood flow.



Aquamasseur Injector Choices

Standard Cap
White, Biscuit or Bone
Actual Diameter - 15/16"

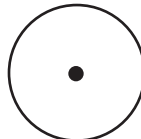

Optional Mini Injectors
18 center cap and trim ring choices
Actual Diameter - 5/8"



ULTIMATE SYSTEM

The ultimate system is a unique combination of our healthmasseur channel technology and our aquamasseur injection technology. In combining the two technologies in one bath, we have provided each of our bathers with an ability to customize their every bath. If their muscles are fatigued they can turn both systems on and get a serious all over tissue massage, but if they are just stressed they can turn on only the aquamasseur system and let thousands of bubbles caress the cares of the day away. If they aren't sure what type of massage they want, they can adjust the two systems until they reach the optimum massage for their day. It is the ability to tailor your massage that results in *"The Ultimate Bathing Experience"*®.

Vision









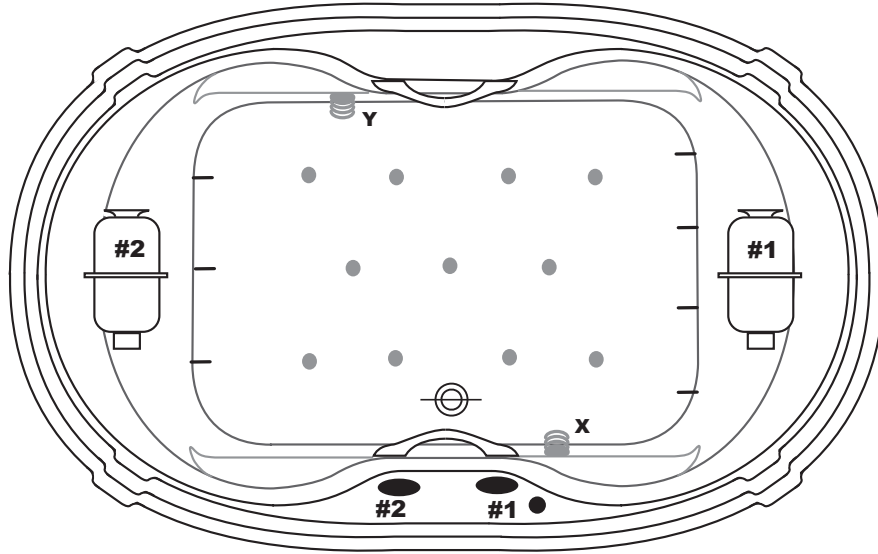



STANDARD POSITIONING













P.O.# _____

Quantity: _____

Cust. ref.# _____



OPTIONS & POSITIONING CHOICES	
Color of bath	<input type="checkbox"/> white, <input type="checkbox"/> biscuit, <input type="checkbox"/> bone, <input type="checkbox"/> other (subject to surcharge): _____ (specify color)
	System: <input type="checkbox"/> Health, <input type="checkbox"/> Aquamasseur, <input type="checkbox"/> Ultimate (Enhanced <input type="checkbox"/> H, <input type="checkbox"/> A, <input type="checkbox"/> U) or <input type="checkbox"/> Soaker
	Multi-Function control: For alternate location indicate desired location and return with order form Select trim color: <input type="checkbox"/> white, <input type="checkbox"/> biscuit, <input type="checkbox"/> chrome, <input type="checkbox"/> nickel, <input type="checkbox"/> gold
	Electronic light control trim color: <input type="checkbox"/> white, <input type="checkbox"/> biscuit, <input type="checkbox"/> chrome, <input type="checkbox"/> nickel, <input type="checkbox"/> gold
	Chromatherapy light (optional) position: <input type="checkbox"/> X or <input type="checkbox"/> Y or <input type="checkbox"/> X and Y (see drawing)
	Acrylic grab bar (optional): <input type="checkbox"/> 8" or N/A quantity <input type="checkbox"/> 1 or <input type="checkbox"/> 2 (If 1, indicate location on drawing) Color: <input type="checkbox"/> white, <input type="checkbox"/> biscuit, <input type="checkbox"/> bone, <input type="checkbox"/> clear with chrome insert, <input type="checkbox"/> clear with gold insert, <input type="checkbox"/> clear with nickel insert
	Injectors: select type <input type="checkbox"/> standard, color: _____ (specify color) or <input type="checkbox"/> mini injectors, center color: _____ (color) / trim color: _____ (color)
	Waterfall fill spout (optional): <input type="checkbox"/> NOT APPLICABLE FOR THIS MODEL
	Overflow: <input type="checkbox"/> A or <input type="checkbox"/> B (see drawing) NOT APPLICABLE FOR THIS MODEL
	Turnstyle drain (optional) _____ (specify color) (field installation required)
	Tiling flange (optional) <input type="checkbox"/> PVC (field installation required) NOT APPLICABLE FOR THIS MODEL N.B. Indicate location on drawing
	Skirt (optional) <input type="checkbox"/> L or <input type="checkbox"/> R or NOT APPLICABLE FOR THIS MODEL Type of skirt: <input type="checkbox"/> Easy access (factory installed), <input type="checkbox"/> Standard (field installation required)
	Blower relocation kit (12') (optional, 1 kit per blower relocation): <input type="checkbox"/> 1 or <input type="checkbox"/> 2

SYMBOL CHART			
	Indicates location of blower		Indicates location of control (system)
	Acrylic grab bar (factory installed)		Indicates location of control (light)
	Indicates location of bottom injectors		Indicates location of wall injectors
	Indicates location of overflow		Indicates location of drain
	Tiling flange		Indicates optional skirt location
	Indicates location of chromatherapy light (optional)		
	Indicates location of optional integrally molded waterfall fill spout		

Final approval: _____ (signature) Printed name: _____ Date: (dd-mm-yy)

December 2008

Vision

STANDARD POSITIONING







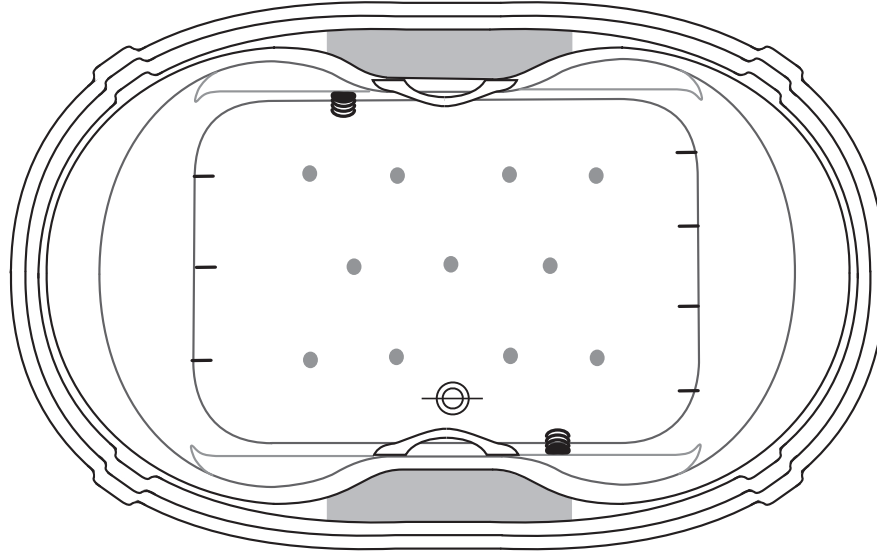

Ultimate II











P.O.# _____

Quantity: _____

Cust. ref.# _____



OPTIONS & POSITIONING CHOICES	
Color of bath	<input type="checkbox"/> white, <input type="checkbox"/> biscuit, <input type="checkbox"/> bone, <input type="checkbox"/> other (subject to surcharge): _____ (specify color)
Control	<input type="checkbox"/> RK (removable keypad) or <input type="checkbox"/> HK (hard wired keypad) (Please draw the control () where you want it mounted within the grey areas)** Select color: <input type="checkbox"/> white or <input type="checkbox"/> biscuit **for alternate location of HK contact Acryline
	Acrylic grab bar (optional): <input type="checkbox"/> 8" or N/A / quantity <input type="checkbox"/> 1 or <input type="checkbox"/> 2 (If 1, indicate location on drawing) Color: <input type="checkbox"/> white, <input type="checkbox"/> biscuit, <input type="checkbox"/> bone, <input type="checkbox"/> clear with chrome insert, <input type="checkbox"/> clear with gold insert, <input type="checkbox"/> clear with nickel insert
	Injectors: select type <input type="checkbox"/> standard, color: _____ (specify color) or <input type="checkbox"/> mini injectors, center color: _____ (color) / trim color: _____ (color)
	Waterfall fill spout (optional): <input type="checkbox"/> NOT APPLICABLE FOR THIS MODEL
	Overflow: <input type="checkbox"/> A or <input type="checkbox"/> B (see drawing) NOT APPLICABLE FOR THIS MODEL
	Turnstyle drain (optional) _____ (specify color) (field installation required)
	Tiling flange (optional) <input type="checkbox"/> PVC (NOT APPLICABLE FOR THIS MODEL) N.B. Indicate location on drawing
	Skirt (optional) <input type="checkbox"/> L or <input type="checkbox"/> R or NOT APPLICABLE FOR THIS MODEL Type of skirt: <input type="checkbox"/> Easy access (factory installed), <input type="checkbox"/> Standard (field installation required)
	Ultimate II dual blower relocation kit (12') (optional) <input type="checkbox"/> (field installation required)

SYMBOL CHART			
	Acrylic grab bar (factory installed)		Indicates location of control (RK or HK)
	Indicates location of bottom injectors		Indicates location of wall injectors
	Indicates location of overflow		Indicates location of drain
	Tiling flange		Indicates optional skirt location
	Indicates location of chromotherapy lights included with Ultimate II		
	Indicates location of optional integrally molded waterfall fill spout		

Final approval: _____ (signature) Printed name: _____ Date: (dd-mm-yy)